

## 400CNQ035/400CNQ040/400CNQ045 SCHOTTKY RECTIFIER



### Features

- 150°C T<sub>J</sub> operation
- Center tap module
- High purity, high temperature epoxy encapsulation for enhanced mechanical strength and moisture resistance
- Low forward voltage drop
- High frequency operation
- Guard ring for enhanced ruggedness and long term reliability
- Base plate: Nickel plated; Terminals: Nickel plated
- The terminal hardware is supplied with the module.
- The mounting hardware is not supplied. Recommended is the use of ¼-20 or M6 screws with spring washer.
- This is a Pb – Free Device
- All SMC parts are traceable to the wafer lot
- Additional testing can be offered upon request

### Circuit Diagram

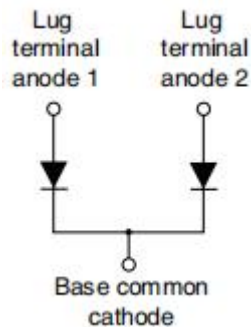

### Applications

- High current switching power supply
- Plating power supply
- Free-Wheeling diodes
- Reverse battery protection
- Converters
- UPS System
- Welding

### Maximum Ratings (limiting values, at 25 °C unless otherwise specified)

Characteristics	Symbol	Condition	Max.	Units
Peak Repetitive Reverse Voltage	V <sub>RRM</sub>	-	35	V
Working Peak Reverse Voltage	V <sub>RWM</sub>		40	
DC Blocking Voltage	V <sub>R</sub>		45	
Average Rectified Forward Current	I <sub>F(AV)</sub>	50% duty cycle @T <sub>C</sub> = 104°C, rectangular wave form	200(Per Leg) 400(Per Device)	A
Peak One Cycle Non-Repetitive Surge Current (Per Leg)	I <sub>FSM</sub>	8.3 ms, half Sine pulse	4080	A
Non-Repetitive Avalanche Energy (Peg Leg)	E <sub>AS</sub>	T <sub>J</sub> = 25°C, I <sub>AS</sub> = 40A, L = 0.22mH	180	mJ
Repetitive Avalanche Current (Peg Leg)	I <sub>AR</sub>	Current decaying linearly to zero in 1 µsec Frequency limited by T <sub>J</sub> max. V <sub>A</sub> = 1.5 × V <sub>R</sub> typical	40	A

**Electrical Characteristics:**

Characteristics	Symbol	Condition	Typ.	Max.	Units
Forward Voltage Drop(Per Leg)*	V <sub>F1</sub>	@ 200A, Pulse, T <sub>J</sub> = 25 °C @ 400A, Pulse, T <sub>J</sub> = 25 °C	0.57 0.69	0.65 0.73	V
	V <sub>F2</sub>	@ 200A, Pulse, T <sub>J</sub> = 125 °C @ 400A, Pulse, T <sub>J</sub> = 125 °C	0.51 0.64	0.55 0.68	V
Reverse Current(Per Leg)*	I <sub>R1</sub>	@V <sub>R</sub> = rated V <sub>R</sub> , T <sub>J</sub> = 25 °C	0.6	20	mA
	I <sub>R2</sub>	@V <sub>R</sub> = rated V <sub>R</sub> , T <sub>J</sub> = 125 °C	132	800	mA
Junction Capacitance(Per leg)	C <sub>T</sub>	@V <sub>R</sub> = 5V, T <sub>C</sub> = 25 °C f <sub>sig</sub> = 1MHz	8670	10300	pF
Voltage Rate of Change	dv/dt	-	-	10,000	V/μs

\* Pulse width < 300 μs, duty cycle < 2%

**Thermal-Mechanical Specifications:**

Characteristics	Symbol	Condition	Specification		Units
Junction Temperature	T <sub>J</sub>	-	-55 to +150		°C
Storage Temperature	T <sub>stg</sub>	-	-55 to +150		°C
Typical Thermal Resistance Junction to Case(Per leg)	R <sub>θJC</sub>	DC operation	0.40		°C/W
Typical Thermal Resistance Junction to Case(Per package)	R <sub>θJC</sub>	DC operation	0.20		°C/W
Typical Thermal Resistance, case to Heat Sink	R <sub>θcs</sub>	Mounting surface, smooth and greased	0.08		°C/W
Mounting Torque	T <sub>M</sub>	-	Mounting Torque	3.84(min) 4.80(max)	Nm
			Terminal Torque	2.35(min) 3.43(max)	
Approximate Weight	wt	-	91		g
Case Style	PRM4 Non-Isolated				

**Ratings and Characteristics Curves**

Figure 1  
Typical Forward Characteristics

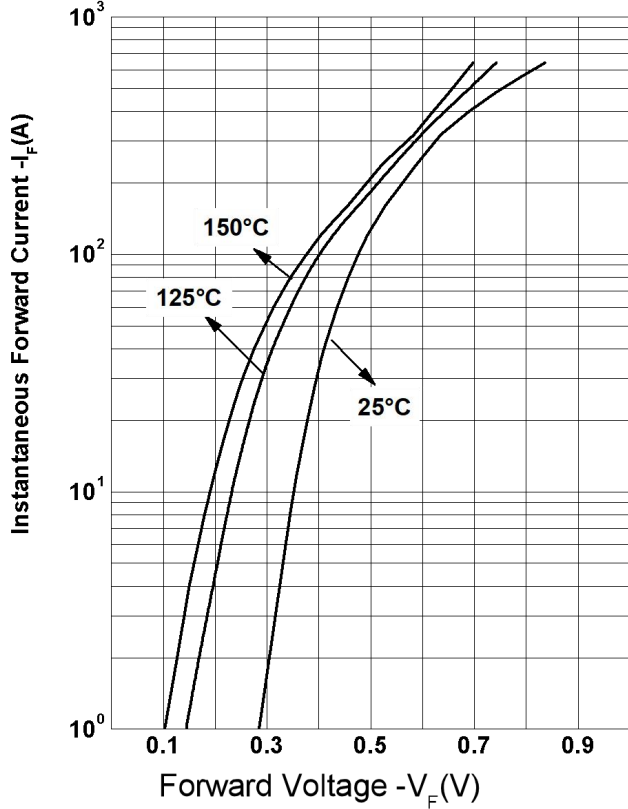

Figure 2  
Typical Reverse Characteristics

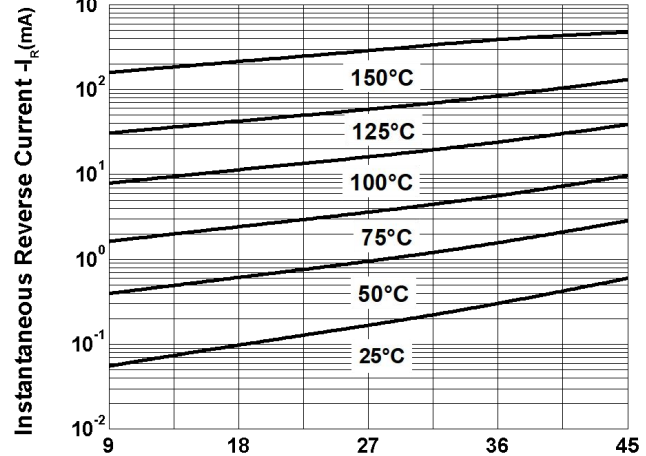
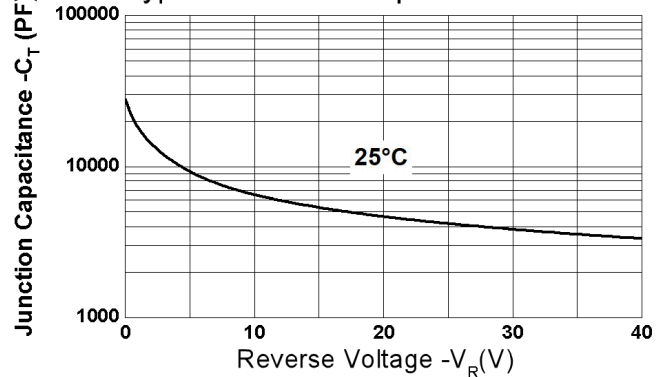
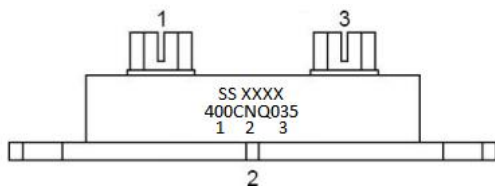

Figure 3  
Typical Junction Capacitance



**Marking Diagram**



Where XXXX is YYWW

400CNQ035 = Part name  
SS = SS  
YY = Year  
WW = Week

Cautions: Molding resin  
Epoxy resin UL:94V-0

**Ordering Information**

Device	Package	Shipping
400 CNQ SERIES	PRM4(Non- Isolated) (Pb-Free)	9 pcs/box

**Mechanical Dimensions PRM4 Non-Isolated(Millimeters/Inches)**

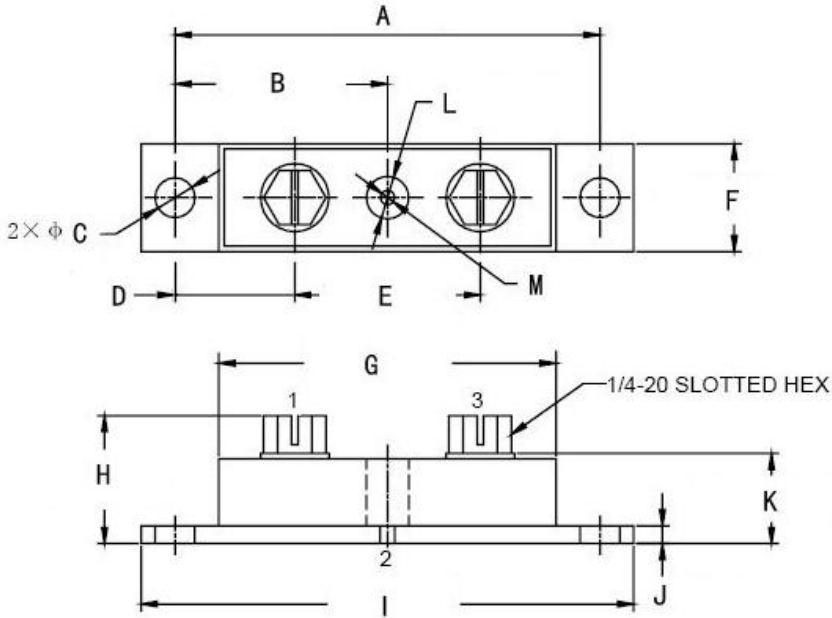

SYMBOL	Millimeters		Inches	
	Min.	Max.	Min.	Max.
A	78.74	81.28	3.100	3.200
B	37.47	42.55	1.475	1.675
C	6.89	7.69	0.271	0.303
D	19.51	24.59	0.768	0.968
E	33.02	38.10	1.300	1.500
F	17.78	20.32	0.700	0.800
G	60.96	64.77	2.400	2.550
H	17.26	23.25	0.680	0.915
I	90.17	92.71	3.550	3.650
J	3.02	3.68	0.119	0.145
K	14.30	16.15	0.563	0.636
L	9.27	10.79	0.365	0.425
M	4.37	5.28	0.172	0.208

**1/4-20 screws (Millimeters)**

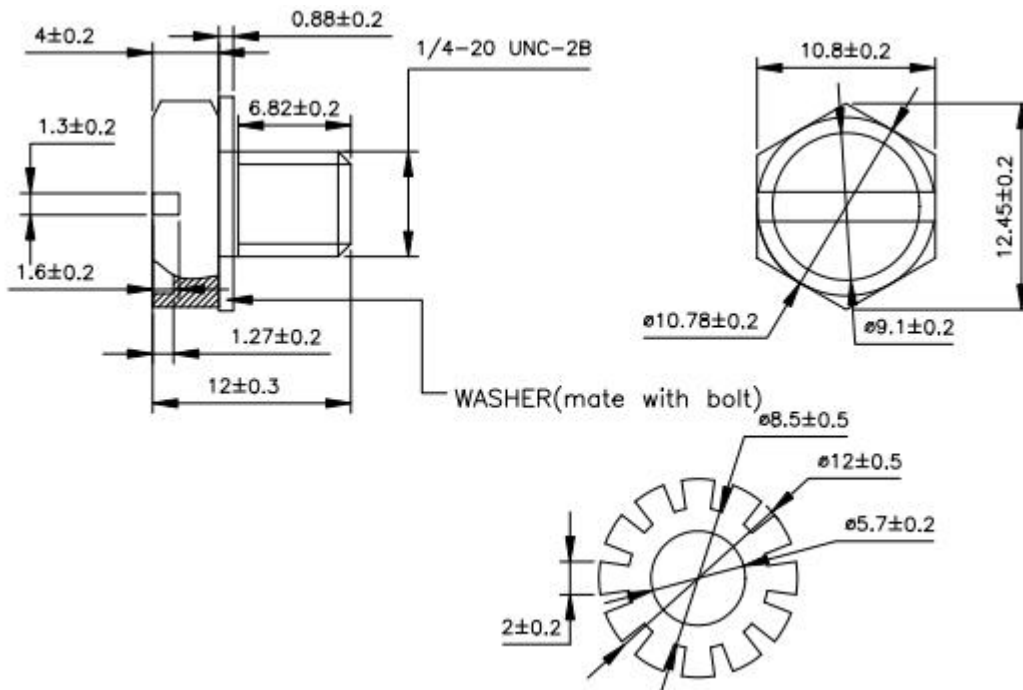

**DISCLAIMER:**

1- The information given herein, including the specifications and dimensions, is subject to change without prior notice to improve product characteristics. Before ordering, purchasers are advised to contact the SMC Diode Solutions sales department for the latest version of the datasheet(s).

2- In cases where extremely high reliability is required (such as use in nuclear power control, aerospace and aviation, traffic equipment, medical equipment, and safety equipment), safety should be ensured by using semiconductor devices that feature assured safety or by means of users' fail-safe precautions or other arrangement.

3- In no event shall SMC Diode Solutions be liable for any damages that may result from an accident or any other cause during operation of the user's units according to the datasheet(s). SMC Diode Solution assumes no responsibility for any intellectual property claims or any other problems that may result from applications of information, products or circuits described in the datasheets.

4- In no event shall SMC Diode Solutions be liable for any failure in a semiconductor device or any secondary damage resulting from use at a value exceeding the absolute maximum rating.

5- No license is granted by the datasheet(s) under any patents or other rights of any third party or SMC Diode Solutions.

6- The datasheet(s) may not be reproduced or duplicated, in any form, in whole or part, without the expressed written permission of SMC Diode Solutions.

7- The products (technologies) described in the datasheet(s) are not to be provided to any party whose purpose in their application will hinder maintenance of international peace and safety nor are they to be applied to that purpose by their direct purchasers or any third party. When exporting these products (technologies), the necessary procedures are to be taken in accordance with related laws and regulations..